



AIR COMPRESSOR

BISON AIMS TO OFFER DISTRIBUTORS A DIVERSE RANGE OF AIR
COMPRESSORS BY RESPONSIVE SERVICE.



TAIZHOU BISON MACHINERY CO.,LTD.

Add: Build D, No.1515 Fengnan East Road, JiaoJiang,
Taizhou City, Zhejiang Province China
Tel: 0086-576-88205202

<http://www.bisoncompressor.com>

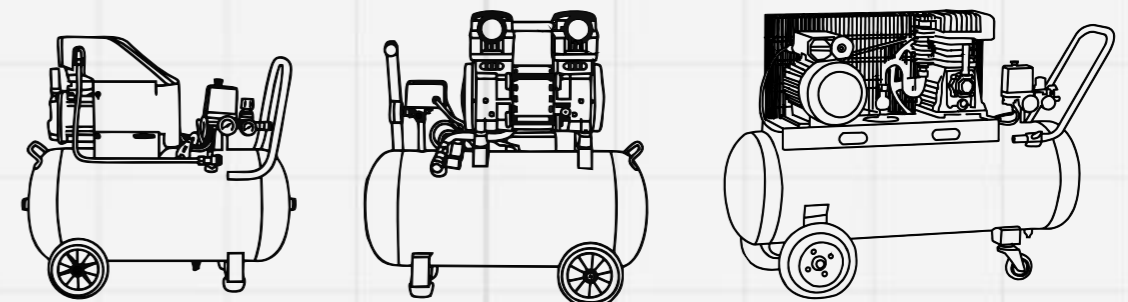

PRODUCTION SHOP



01 EFFICIENT & PRECISE

Each process is completed by the domestic high-end processing equipment, through a complete set of advanced processing equipment to ensure that products in the processing accuracy and matching in the market leader.



02 PROFESSIONAL & CONTROL

Company in the production process in strict accordance with international quality system standards, production departments in the picking must carry out prenatal inspection, the production process of each process must be inspected, after the completion of the process must be a full range of product performance testing.



03 LEAN MANAGEMENT

Company strictly enforce the age management, location management, inventory early warning, through the strict requirements of inventory management, can ensure a reasonable safety inventory, in order to meet customer demand for order delivery timely, convenience.

PRODUCTION
PROCESS





DIRECT OIL LUBRICATED COMPRESSOR 01-07

SILENCE OILFREE COMPRESSOR 08-10

Low Noise 2 Pole OILFREE COMPRESSOR 11-15

BELT OIL LUBRICATED COMPRESSOR 16-21

AIR COMPRESSOR HEAD 22-24

ACCESSORIES 25-26

DIAGRAM 27-28

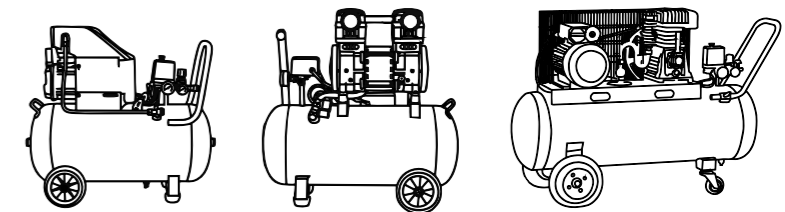

Born for the ultimate



Products contents

AIR COMPRESSOR

DIRECT OIL LUBRICATED COMPRESSOR





DIRECT OIL LUBRICATED COMPRESSOR



TECHNICAL PARAMETER

Model	Tank		Voltage/ Frequency V/Hz	Power		Speed rpm	Noise dB	Air Displacement		Work Pressure		N.W kg	Dimensions L*W*H (cm)	MOQ		
	L	Gal		kW	HP			L/min	CFM	Bar	Psi			20'	40'	40'H
DO42TA-24	24	6.3	230/50	1.1	1.5	2850	85	135	4.8	8.0	115	20	58.5x25.5x58	360	720	720
DO42TA-24	24	6.3	120/60	1.1	1.5	3450	88	155	5.5	8.8	125	21	58.5x25.5x58	360	720	720
DO47TA-24	24	6.3	230/50	1.5	2.0	2850	89	185	6.4	8.0	115	22	58.5x25.5x58	360	720	720
DO47TA-24	24	6.3	120/60	1.7	2.5	3450	91	240	8.5	8.8	125	24	58.5x25.5x58	360	720	720
DO51TA-24	24	6.3	230/50	1.7	2.5	2850	89	240	8.5	8.0	115	24	58.5x25.5x58	360	720	720

DIRECT OIL LUBRICATED COMPRESSOR



Model	DO42TA-8		
Tank	L	6	10
	Gal	2.5	2.5
Voltage/ Frequency V/Hz	230/50		120/60
	Power	kW	1.1
HP		1.5	1.5
Speed	2850		3450
	Noise	85	
Air Displacement		L/min	135
	CFM	4.8	5.5
Work Pressure	Bar	8	8.8
	Psi	115	125
N.W	16		17
	Dimensions L*W*H (cm)	49x21x50.5	
MOQ		20'	528
	40'	1056	912
	40'H	1320	1140



Model	DO47TA-50		DO51TA-50	
Tank	L	50	50	50
	Gal	12.6	12.6	12.6
Voltage/ Frequency V/Hz	230/50		120/60	230/50
	Power	kW	1.5	1.7
HP		2.0	2.5	2.5
Speed	2850		3450	2850
	Noise	89		91
Air Displacement		L/min	185	240
	CFM	6.4	8.5	8.5
Work Pressure	Bar	8.0	8.8	8.0
	Psi	115	125	115
N.W	33		34	34
	Dimensions L*W*H (cm)	74x33x72		74x33x72
MOQ		20'	156	156
	40'	315	315	315
	40'H	315	315	315



DIRECT OIL LUBRICATED COMPRESSOR

DIRECT OIL LUBRICATED COMPRESSOR

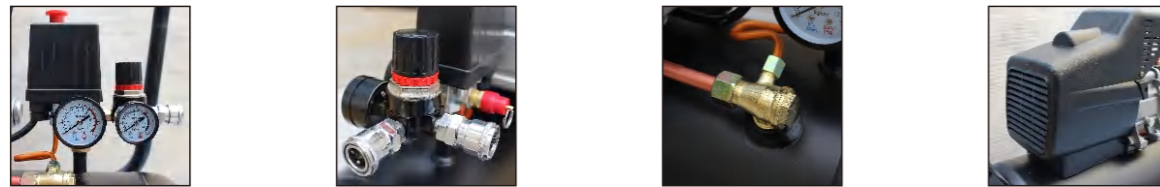

Model	DO47BM-50		DO51BM-50
Tank	L	50	50
	Gal	12.6	12.6
Voltage/ Frequency V/Hz		230/50	120/60
		230/50	230/50
Power	kW	1.5	1.7
	HP	2.0	2.5
Speed	rpm	2850	3450
Noise	dB	89	91
Air Displacement	L/min	185	240
	CFM	6.4	8.5
Work Pressure	Bar	8.0	8.8
	Psi	115	125
N.W	kg	33	34
Dimensions	L*W*H (cm)	74x33x72	74x33x72
		20'	156
MOQ	40'	315	315
	40'H	315	315

TECHNICAL PARAMETER

Model	Tank		Voltage/ Frequency V/Hz	Power		Speed rpm	Noise	Air Displacement		Work Pressure		N.W kg	Dimensions L*W*H (cm)	MOQ		
	L	Gal		kW	HP			L/min	CFM	Bar	Psi			20'	40'	40'H
DO42BM-24	24	6.3	230/50	1.1	1.5	2850	85	135	4.8	8.0	115	20	58.5x28.5x63	270	540	640
DO42BM-24	24	6.3	120/60	1.1	1.5	3450	88	155	5.5	8.8	125	21	58.5x28.5x63	270	540	640
DO47BM-24	24	6.3	230/50	1.5	2.0	2850	89	185	6.4	8.0	115	22	58.5x28.5x63	270	540	640
DO47BM-24	24	6.3	120/60	1.7	2.5	3450	91	240	8.5	8.8	125	24	58.5x28.5x63	270	540	640
DO51BM-24	24	6.3	230/50	1.7	2.5	2850	89	240	8.5	8.0	115	24	58.5x28.5x63	270	540	640



Model	DO47BM-50V		DO51BM-50V
Tank	L	50	50
	Gal	12.6	12.6
Voltage/ Frequency V/Hz		230/50	120/60
		230/50	230/50
Power	kW	1.5	1.7
	HP	2.0	2.5
Speed	rpm	2850	3450
Noise	dB	89	91
Air Displacement	L/min	185	240
	CFM	6.4	8.5
Work Pressure	Bar	8.0	8.8
	Psi	115	125
N.W	kg	38	39
Dimensions	L*W*H (cm)	45x42x114	45x42x114
		20'	140
MOQ	40'	280	280
	40'H	280	280



DIRECT OIL LUBRICATED COMPRESSOR



Model	DV47-50	DV47-100
L	50	50
Tank Gal	12.6	12.6
Voltage/Frequency V/Hz	230/50	230/50
Power kW	2.2	2.2
Power HP	3.0	3.0
Speed rpm	2850	2850
Noise dB	90	90
Air Displacement L/min	360	360
Air Displacement CFM	12.7	12.7
Work Pressure Bar	8	8
Work Pressure Psi	115	115
Weight kg	42	55
Dimensions L*W*H (cm)	76x38.5x72	90x42x77
MOQ 20'	126	102
MOQ 40'	270	207
MOQ 40'H	270	207

SILENCE OILFREE COMPRESSOR



Model	OF550-8	
L	8	8
Tank Gal	2.5	2.5
Voltage/Frequency V/Hz	230/50	120/60
Power kW	0.55	0.55
Power HP	0.75	0.75
Speed rpm	1400	1700
Noise dB	68	70
Air Displacement L/min	100	110
Air Displacement CFM	3.5	3.8
Work Pressure Bar	8	8.8
Work Pressure Psi	115	125
Weight kg	15	15
Dimensions L*W*H (cm)	51x21x50.5	51x21x50.5
MOQ 20'	528	528
MOQ 40'	1056	1056
MOQ 40'H	1320	1320



Model	OF750-24	
L	24	24
Tank Gal	6.3	6.3
Voltage/Frequency V/Hz	230/50	120/60
Power kW	0.75	0.75
Power HP	1.0	1.0
Speed rpm	1400	1700
Noise dB	70	72
Air Displacement L/min	130	150
Air Displacement CFM	4.6	5.3
Work Pressure Bar	8	8.8
Work Pressure Psi	115	125
Weight kg	23	23
Dimensions L*W*H (cm)	58.5x25.5x58	58.5x25.5x58
MOQ 20'	360	360
MOQ 40'	720	720
MOQ 40'H	720	720

SILENCE OILFREE COMPRESSOR



Model	OF550X2-50	OF750X2-50
L	50	50
Tank Gal	12.5	12.5
Voltage/Frequency V/Hz	230/50	230/50
Power kW	1.1	1.5
Power HP	1.5	2.0
Speed rpm	1400	1400
Noise dB	68	70
Air Displacement L/min	200	260
CFM	7.0	7.7
Work Pressure Bar	8.0	8.0
Psi	115	115
N.W. kg	42	42
Dimensions L*W*H (cm)	73x33x67	73x33x67
MOQ	20'	160
	40'	330
	40'H	440

SILENCE OILFREE COMPRESSOR



Model	OF550X3-70	OF750X3-70
L	70	70
Tank Gal	18.5	18.5
Voltage/Frequency V/Hz	230/50	230/50
Power kW	1.6	2.2
Power HP	2.2	3.0
Speed rpm	1400	1400
Noise dB	68	70
Air Displacement L/min	300	390
CFM	10.5	13.7
Work Pressure Bar	8.0	8.0
Psi	115	115
N.W. kg	51	51
Dimensions L*W*H (cm)	90x33x67	90x33x67
MOQ	20'	90
	40'	180
	40'H	180



Model	OF1100x2-50 (四极)
L	50
Tank Gal	12.5
Voltage/Frequency V/Hz	230/50
Power kW	2.2
Power HP	3.0
Speed rpm	1400
Noise dB	72
Air Displacement L/min	384
CFM	13.5
Work Pressure Bar	8.0
Psi	115
N.W. kg	56
Dimensions L*W*H (cm)	73x33x67
MOQ	20'
	40'
	40'H



Model	OF1100x3-100 (四极的)
L	100
Tank Gal	25
Voltage/Frequency V/Hz	230/50
Power kW	3.3
Power HP	5.0
Speed rpm	1400
Noise dB	72
Air Displacement L/min	576
CFM	20.2
Work Pressure Bar	8.0
Psi	115
N.W. kg	81
Dimensions L*W*H (cm)	110x42x84
MOQ	20'
	40'
	40'H



Low Noise 2 Pole OILFREE COMPRESSOR



Low Noise 2 Pole OILFREE COMPRESSOR



Model	DOF1100-6F	
Tank	L	6
	Gal	2
Voltage/Frequency	V/Hz	230/50
Power	kW	1.1
	HP	1.5
Speed	rpm	2800
Noise	dB	73
Air Displacement	L/min	190
	CFM	6.7
Work Pressure	Bar	8.0
	Psi	115
N.W	kg	16
Dimensions	L*W*H (cm)	50x45x50
MOQ	20'	500
	40'	1000
	40'H	1000

Low Noise 2 Pole OILFREE COMPRESSOR



Model	DOF1100-50	DOF1500-50
Tank	L	50
	Gal	12.5
Voltage/Frequency	V/Hz	230/50
Power	kW	1.1
	HP	1.5
Speed	rpm	2800
Noise	dB	73
Air Displacement	L/min	190
	CFM	6.7
Work Pressure	Bar	8.0
	Psi	115
N.W	kg	36
Dimensions	L*W*H (cm)	73x33x67
MOQ	20'	160
	40'	330
	40'H	440



Model	DOF1100-24	DOF1500-24
Tank	L	24
	Gal	6.3
Voltage/Frequency	V/Hz	230/50
Power	kW	1.1
	HP	1.5
Speed	rpm	2800
Noise	dB	73
Air Displacement	L/min	190
	CFM	6.7
Work Pressure	Bar	8.0
	Psi	115
N.W	kg	24
Dimensions	L*W*H (cm)	58.5x25.5x58
MOQ	20'	360
	40'	720
	40'H	720



Model	DOF1100x2-50	DOF1500x2-50
Tank	L	50
	Gal	12.5
Voltage/Frequency	V/Hz	230/50
Power	kW	1.1*2
	HP	3.0
Speed	rpm	2800
Noise	dB	74
Air Displacement	L/min	380
	CFM	13.4
Work Pressure	Bar	8.0
	Psi	115
N.W	kg	43
Dimensions	L*W*H (cm)	73x33x67
MOQ	20'	160
	40'	330
	40'H	440

Low Noise 2 Pole OILFREE COMPRESSOR



Model		D0F1500-50V
Tank	L	50
	Gal	12.5
Voltage/Frequency	V/Hz	230/50
Power	kW	1.5
	HP	2.0
Speed	rpm	2800
Noise	dB	73
Air Displacement	L/min	250
	CFM	8.8
Work Pressure	Bar	8.0
	Psi	115
N.W	kg	42
Dimensions	L*W*H (cm)	38x37x82
MOQ	20'	160
	40'	330
	40'H	440

BELT OIL LUBRICATED COMPRESSOR



Model		BH65-50	BH65b-50
Tank	L	50	50
	Gal	12.6	12.6
Voltage/Frequency	V/Hz	230/50	230/50
Power	kW	1.8	2.2
	HP	2.5	3.0
Speed	rpm	800	950
Noise	dB	77	77
Air Displacement	L/min	260	370
	CFM	9.2	13.1
Work Pressure	Bar	8.0	8.0
	Psi	115	115
N.W	kg	54	58
Dimensions	L*W*H (cm)	95x38.5x72	95x38.5x72
MOQ	20'	108	108
	40'	222	222
	40'H	222	222



Model		BH65-100	BH65b-100
Tank	L	100	100
	Gal	25.2	25.2
Voltage/Frequency	V/Hz	230/50	230/50
Power	kW	1.8	2.2
	HP	2.5	3.0
Speed	rpm	800	950
Noise	dB	77	77
Air Displacement	L/min	260	370
	CFM	9.2	13.1
Work Pressure	Bar	8.0	8.0
	Psi	115	115
N.W	kg	74	78
Dimensions	L*W*H (cm)	108x45x84	108x45x84
MOQ	20'	50	50
	40'	100	100
	40'H	150	150

BELT OIL LUBRICATED COMPRESSOR



Model	BH65-100V	BH65b-100V
L Tank Gal	100	100
Voltage/Frequency V/Hz	230/50	230/50
Power kW/HP	1.8/2.5	2.2/3.0
Speed rpm	800	950
Noise dB	77	77
Air Displacement L/min/CFM	260/9.2	370/13.1
Work Pressure Bar/Psi	8.0/115	8.0/115
Weight N.W. kg	84	88
Dimensions L*W*H (cm)	48x48x92	48x48x92
MOQ	20' 40' 40'H	60 120 120

BELT OIL LUBRICATED COMPRESSOR



Model	BV51-50	BV65-50
L Tank Gal	50	50
Voltage/Frequency V/Hz	230/50	230/50
Power kW/HP	1.5/2.0	2.2/3.0
Speed rpm	950	950
Noise dB	79	79
Air Displacement L/min/CFM	180/7.4	280/10.9
Work Pressure Bar/Psi	8.0/115	8.0/115
Weight N.W. kg	56	60
Dimensions L*W*H (cm)	95x38.5x72	95x38.5x72
MOQ	20' 40' 40'H	108 222 222



Model	Z1051-40
L Tank Gal	40/10
Voltage/Frequency V/Hz	230/50
Power kW/HP	0.75/1.0
Speed rpm	950
Noise dB	76
Air Displacement L/min/CFM	75/2.6
Work Pressure Bar/Psi	8.0/115
Weight N.W. kg	32
Dimensions L*W*H (cm)	70x38x67
MOQ	20' 40' 40'H



Model	BV51-100	BV65-100
L Tank Gal	100	100
Voltage/Frequency V/Hz	230/50	230/50
Power kW/HP	1.5/2.0	2.2/3.0
Speed rpm	950	950
Noise dB	79	79
Air Displacement L/min/CFM	180/7.4	280/10.9
Work Pressure Bar/Psi	8.0/115	8.0/115
Weight N.W. kg	56	60
Dimensions L*W*H (cm)	108x45x84	108x45x84
MOQ	20' 40' 40'H	50 100 150



BELT OIL LUBRICATED COMPRESSOR

BELT OIL LUBRICATED COMPRESSOR



Model		W3065-150
Tank	L	150
	Gal	25.2
Voltage/ Frequency V/Hz		230/50
Power	kW	3.0
	HP	4.0
Speed	rpm	950
Noise	dB	79
Air Displacement	L/min	420
	CFM	16.4
Work Pressure	Bar	8.0
	Psi	115
N.W	kg	85
Dimensions L*W*H (cm)		128x50x88
MOQ	20'	40
	40'	80
	40'H	120



Model		BW80-270	BW90-270
Tank	L	270	500
	Gal	71.3	126
Voltage/ Frequency V/Hz		380/50/3Phase	380/50/3Phase
Power	kW	5.5	7.5
	HP	7.5	10.5
Speed	rpm	900	900
Noise	dB	92	93
Air Displacement	L/min	855	1090
	CFM	30.1	38.5
Work Pressure	Bar	8.0	8.0
	Psi	115	115
N.W	kg	239	258
Dimensions L*W*H (cm)		161x54x115	161x54x115
MOQ	20'	30	30
	40'	60	60
	40'H	60	60



Model		BV80-270	BV90-270
Tank	L	270	270
	Gal	71.3	71.3
Voltage/ Frequency V/Hz		380/50/3Phase	380/50/3Phase
Power	kW	4.0	5.5
	HP	5.0	7.5
Speed	rpm	900	900
Noise	dB	92	92
Air Displacement	L/min	570	730
	CFM	20.1	25.7
Work Pressure	Bar	8.0	8.0
	Psi	115	115
N.W	kg	229	239
Dimensions L*W*H (cm)		161x54x115	161x54x115
MOQ	20'	30	30
	40'	60	60
	40'H	60	60



Model		BW90-500
Tank	L	500
	Gal	126
Voltage/ Frequency V/Hz		380/50/3Phase
Power	kW	7.5
	HP	10
Speed	rpm	900
Noise	dB	93
Air Displacement	L/min	1090
	CFM	38.5
Work Pressure	Bar	12.5
	Psi	181
N.W	kg	384
Dimensions L*W*H (cm)		183x70x133
MOQ	20'	18
	40'	36
	40'H	36



BELT OIL LUBRICATED COMPRESSOR



Model	BH65PE-50	
Tank	L	50
	Gal	12.6
Voltage/ Frequency V/Hz	Bison Petrol Engine	
	kW	6.5
Power	HP	6.5
	Speed	950
Noise	rpm	950
	dB	91
Air Displacement	L/min	370
	CFM	13.1
Work Pressure	Bar	8.0
	Psi	115
N.W	kg	54
	Dimensions L*W*H (cm)	95x38.5x72
MOQ	20'	108
	40'	222
	40'H	222



Model	BH65PE-100	
Tank	L	100
	Gal	25.2
Voltage/ Frequency V/Hz	Bison Petrol Engine	
	kW	6.5
Power	HP	6.5
	Speed	950
Noise	rpm	950
	dB	91
Air Displacement	L/min	370
	CFM	13.1
Work Pressure	Bar	8.0
	Psi	115
N.W	kg	78
	Dimensions L*W*H (cm)	108x45x84
MOQ	20'	50
	40'	100
	40'H	150

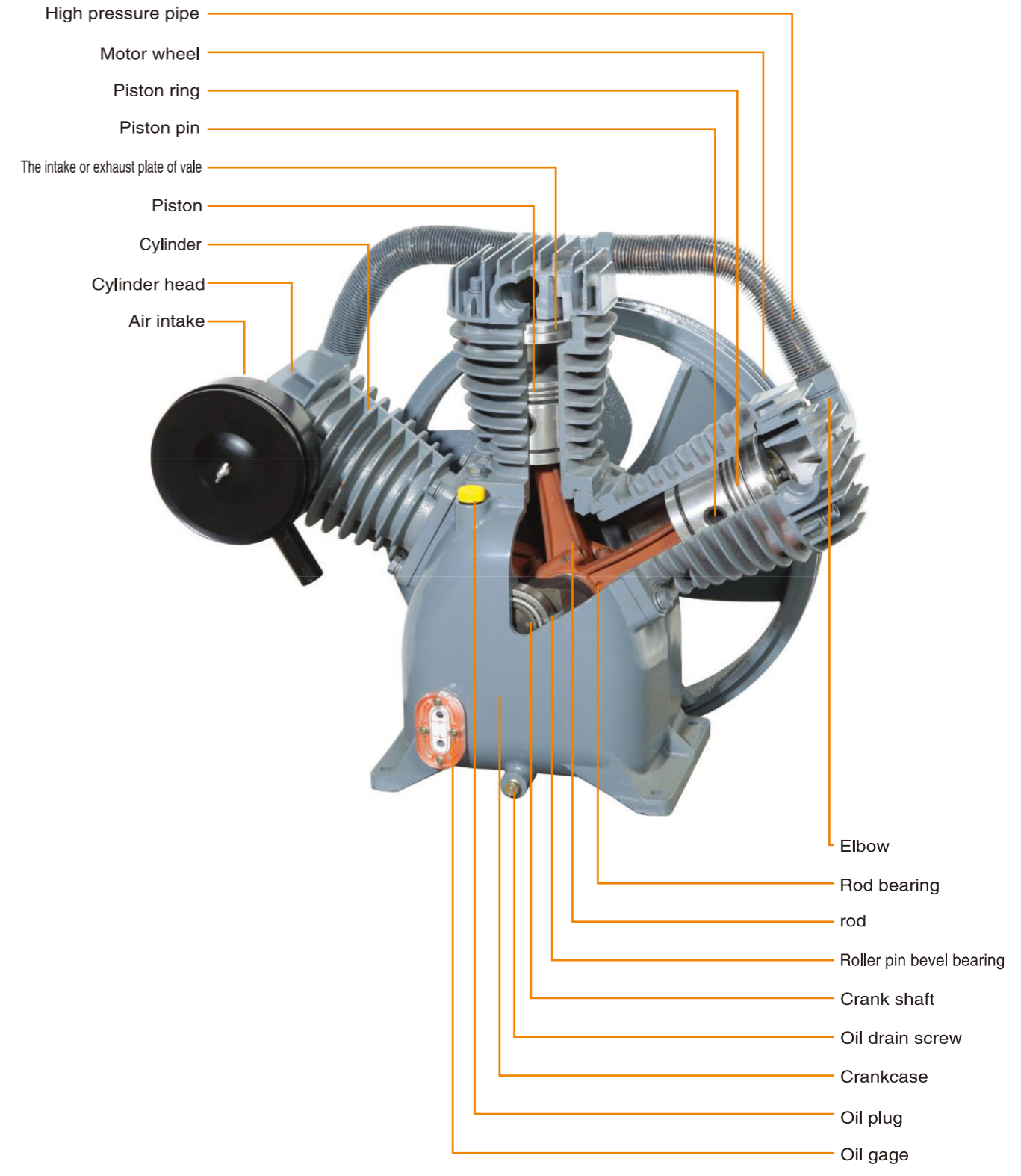



AIR COMPRESSOR HEAD



550W/750W

1.1/1.5KW

TECHNICAL PARAMETER

Model	Power kW HP	Voltage/ Frequency V/Hz	Speed rpm	Air Displacement L/min	Max Pressure bar	Cylinder Dia DB/A	N.W kg	Dimensions L*W*H (cm)
MB550W/E	0.55 0.75	220/380/50	1450	107 3.8	8 115	53	7	270×135×190
MB750W/E	0.75 1.0	220/380/50	1450	138 4.8	8 115	57	8	270×135×215
MB1100W/E	1.1 1.5	220/380/50	1450	200 7.0	8 115	66	15	330×160×285
MB1500W/E	1.5 2.0	220/380/50	1450	245 8.6	8 115	66	17	330×160×285



TECHNICAL PARAMETER

Model	Power kW HP	Air Displacement L/min	Max Pressure bar	Cylinder Dia DB/A	N.W kg	Dimensions L*W*H (cm)
MB-H2055	1.5 2.0	190 6.7	8	Φ55×2	9	29×23×29
MB-H2060	1.5 2.0	190 6.7	8	Φ60×2	9	29×23×29
MB-H2065	2.2 3.0	250 8.8	8	Φ65×2	10	29×24×31
MB-H2070	2.2 3.0	300 10.6	8	Φ70×2	10	29×24×35
MB-H2080	3.0 4.0	480 16.9	8	Φ80×2	21	39×39×40
MB-H2090	4.0 5.5	600 21.0	8	Φ90×2	22	39×39×40

AIR COMPRESSOR HEAD

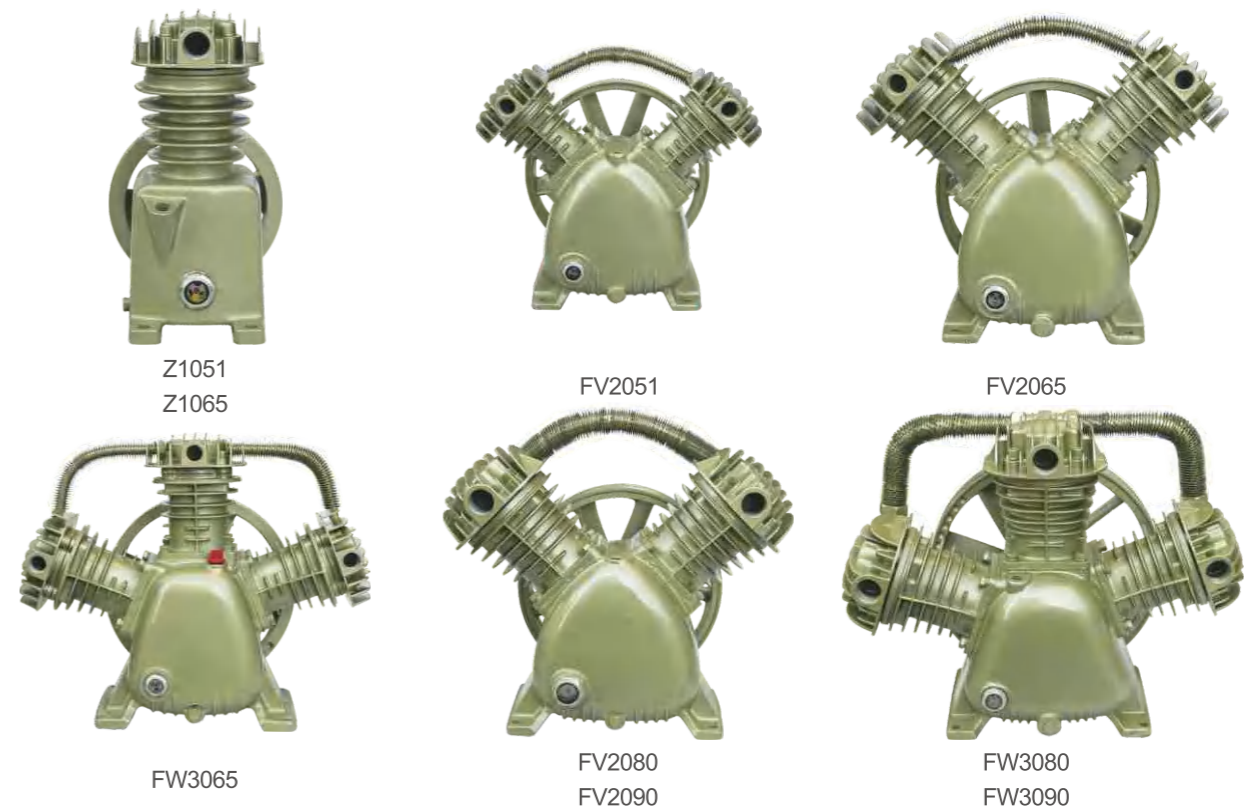

Z1051
Z1065

FV2051

FV2065

FW3065

FV2080
FV2090

FW3080
FW3090

TECHNICAL PARAMETER

技术参数

型号 Model	功率/Power kW HP	额定容积流量 Air Displacement L/min	最高压力 Max Pressure bar	机头 Cylinder Dia DB/A	重量 N.W kg	外型尺寸 Dimensions L*W*H (cm)
Z1051	0.75 1.0	36	8	Φ51×1	7.5	21×16×26
Z1065	0.75 1.0	80	8	Φ65×1	9	26×20×29
FV2051	1.5 2	170	8	Φ51×2	15	38×25×34
FV2065	2.2 3.0	250/200	8/12.5	Φ65×2(Φ51×1)	20	39×26×35
FW3065	3.0 4.0	360/280	8/12.5	Φ65×3(Φ51×1)	30	44×28×35
FV2080	4.0 5.5	480/380	8/12.5	Φ80×2(Φ65×1)	34	57×50×45
FV2090	4.0 5.5	600/400	8/12.5	Φ90×2(Φ65×1)	35	57×51×46
FW3080	5.5 7.5	670/530	8/12.5	Φ80×3(Φ65×1)	42	63×54×47
FW3090	7.5 10	900/710	8/12.5	Φ90×3(Φ65×1)	44	63×55×48



压力表
PRESSURE GAUGE



球阀
BALL VALVE



安全阀
SAFETY VALVE



阀板
PLATE



油镜、油封、油塞、呼吸器
OIL LEVEL INDICATOR
OIL SEAL
OIL PLUG
OIL BREATHER



活塞、活塞环
PISTON, PISTON RING



接头
QUICK CINNECT COUPLER



单向阀
NON-RETURN VALVE



消音器
MUFFLER



连杆
CONNECTING ROD

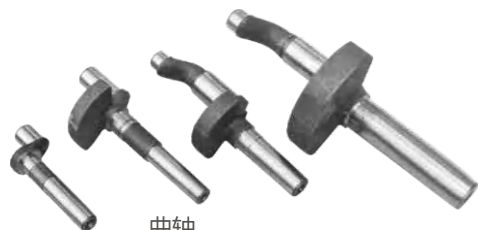

曲轴
CRANKSHAFT



压力开关
PRESSURE SWITCH



调压过滤器
OIL-WATER SEPARATOR

电容
CAPACITOR



电磁保护器
MAGNETIC PROTECTOR



调压阀
REGULATOR ASSEMBLY

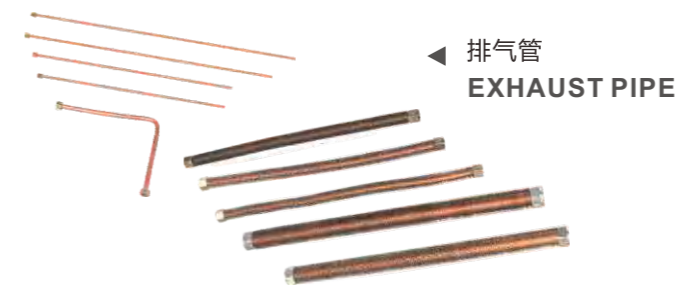

排气管
EXHAUST PIPE



脚轮
WHEEL

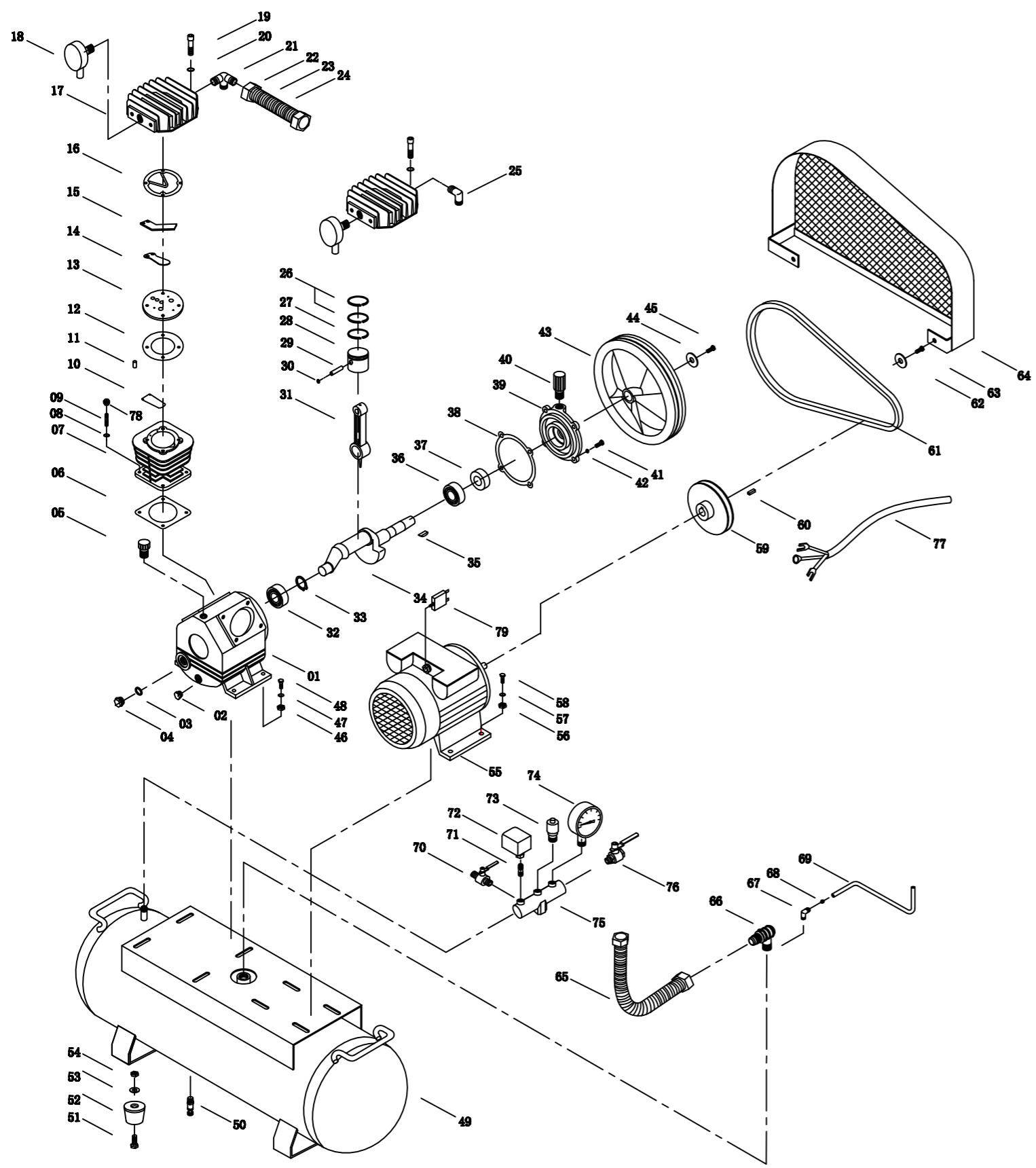

V-belt Type Spare Parts List

- | | | |
|-----------------------------|---------------------------|----------------------------|
| 1.Crankcase | 13.Valve plate | 25.Elbow |
| 2.Drain plug | 14.Exhaust valve | 26.Piston ring |
| 3.Oil immersion lens gasket | 15.Valves stopper | 27.Oil ring |
| 4.Oil immersion lens | 16.Cylinder head gasket | 28.Piston |
| 5.Refueling plug | 17.Cylinder head | 29.Piston pin |
| 6.Cylinder head gasket | 18.air filter | 30.Hole retaining ring |
| 7.Cylinder | 19.hex head screw | 31.Connecting rod |
| 8.Spring gasket | 20.Spring gasket | 32.Bearing |
| 9.Double-threaded screw | 21.Three-way elbow | 33.Bearing retaining ring |
| 10.Intake valve films | 22.Iron nut | 34.Bent axle |
| 11.Locating pin | 23.Row cooling tube | 35.Woodruff key |
| 12.Valve gasket | 24.Heat sink | 36.Bearing |
| 37.Oil seal | 49.Tank | 61.V-belt |
| 38.Bearing seat gasket | 50.Drain plug | 62.Flat gasket |
| 39.Bearing seat | 51.Outside hex head screw | 63.Outside hex head screw |
| 40.Breather | 52.Ribber pad | 64.Safety guard |
| 41.Outside hex head screw | 53.Spring gasket | 65.Exhaust coppery pipe |
| 42.Spring gasket | 54.Nut | 66.Check valve |
| 43.Pulley | 55.single-phase motor | 67.Unloading load elbow |
| 44.Big flat gasket | 56.Nut | 68.Unloading locking ring |
| 45.Outside hex head screw | 57.Spring gasket | 69.Unloading pipe |
| 46.Nut | 58.Outside hex head screw | 70.Exhaust valve |
| 47.Spring gasket | 59.Motor pulley | 71.Double-headed connector |
| 48.Outside hex head screw | 60.Flat key | 72.Pressure switch |
| 73.Safety valve | | |
| 74.Pressure gauge | | |
| 75.Beam | | |
| 76.Exhaust valve | | |
| 77.Power line | | |
| 78.Nut | | |
| 79.Motor protector | | |



BISON BRAND DISTRIBUTION MAP



- CHINA
- THAILAND
- CAMBODIA
- NEW ZEALAND
- AUSTRALIA
- SAUDIARABIA
- NIGERIA
- EGYPT
- ETHIOPIA
- SOUTH AFRICA
- ITALY
- UK
- GERMANY
- RUSSIA
- PERU
- ARGENTINA